

## Montážní návod

pro dvojitou otočnou konstrukci pro svislou skříň 60

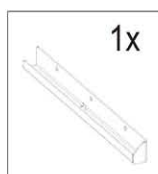

1x

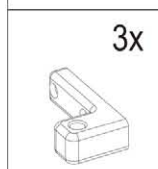

3x

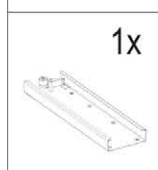

1x

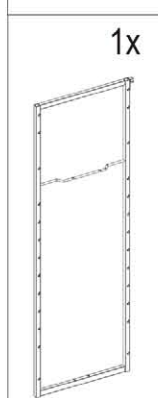

1x

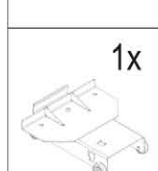

1x

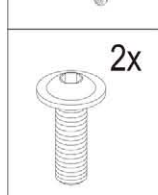

2x

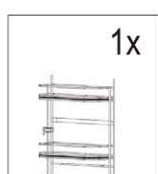

1x



2x



2x

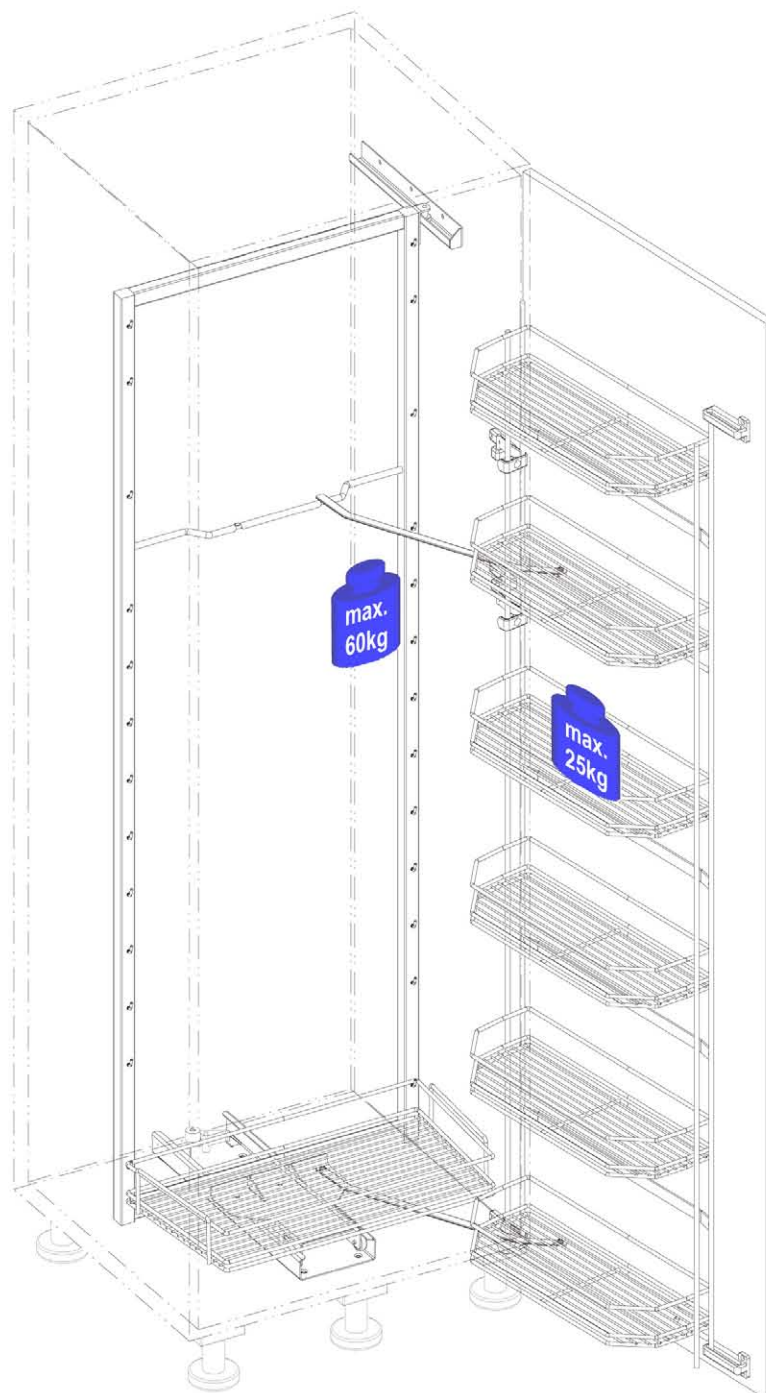
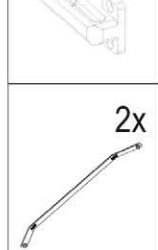

## 1a. Dveře vpravo

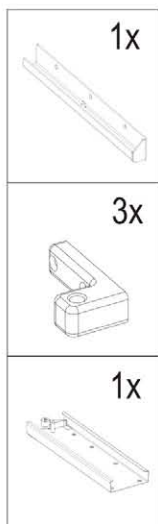

Pokud by měl být ve výši horního ložiska namontován závěs dveří, je nutno ložisko namontovat příslušně níže.

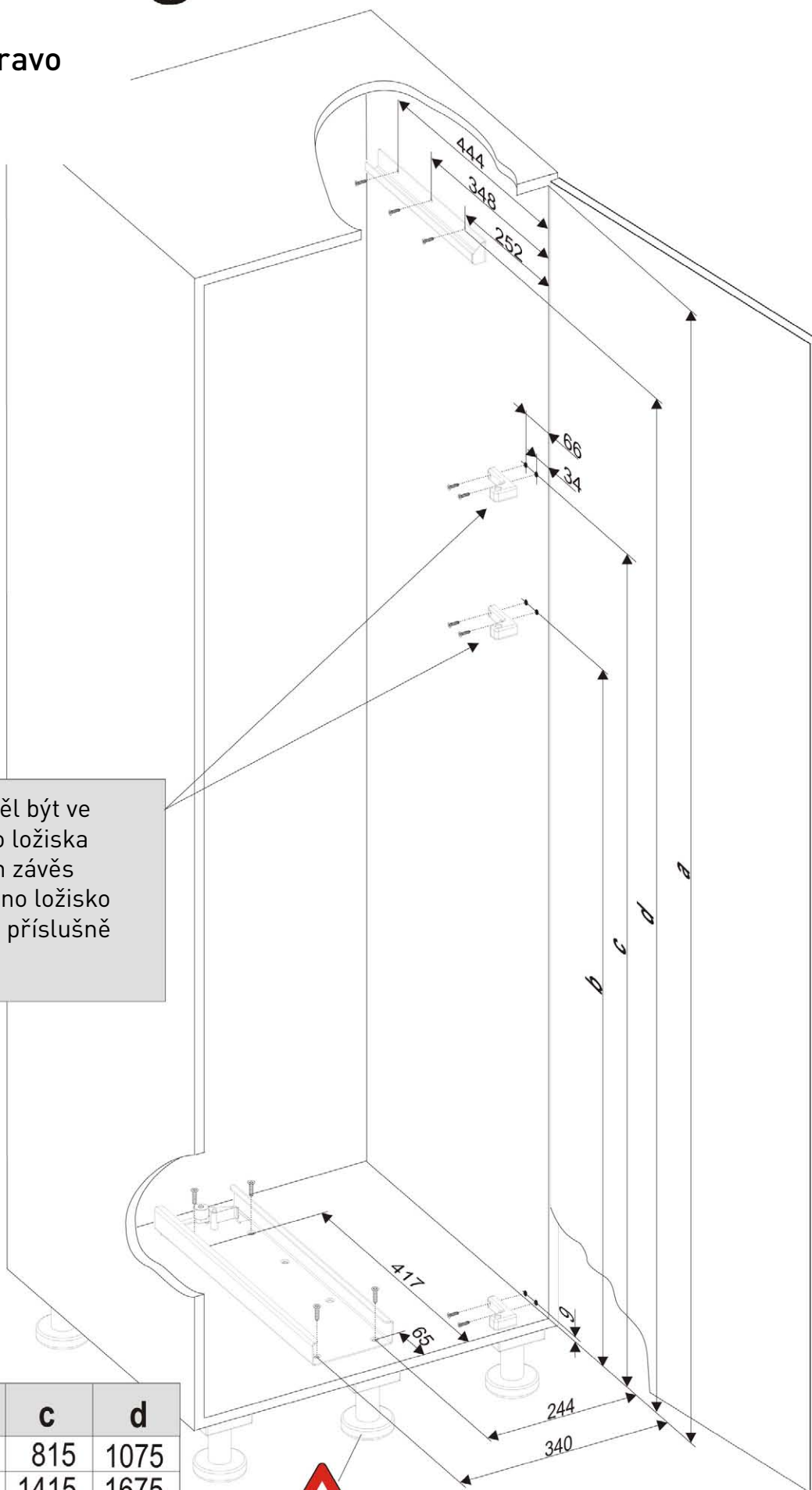

a	b	c	d
min. 1100	625	815	1075
min. 1700	1225	1415	1675



## 1b. Dveře vpravo

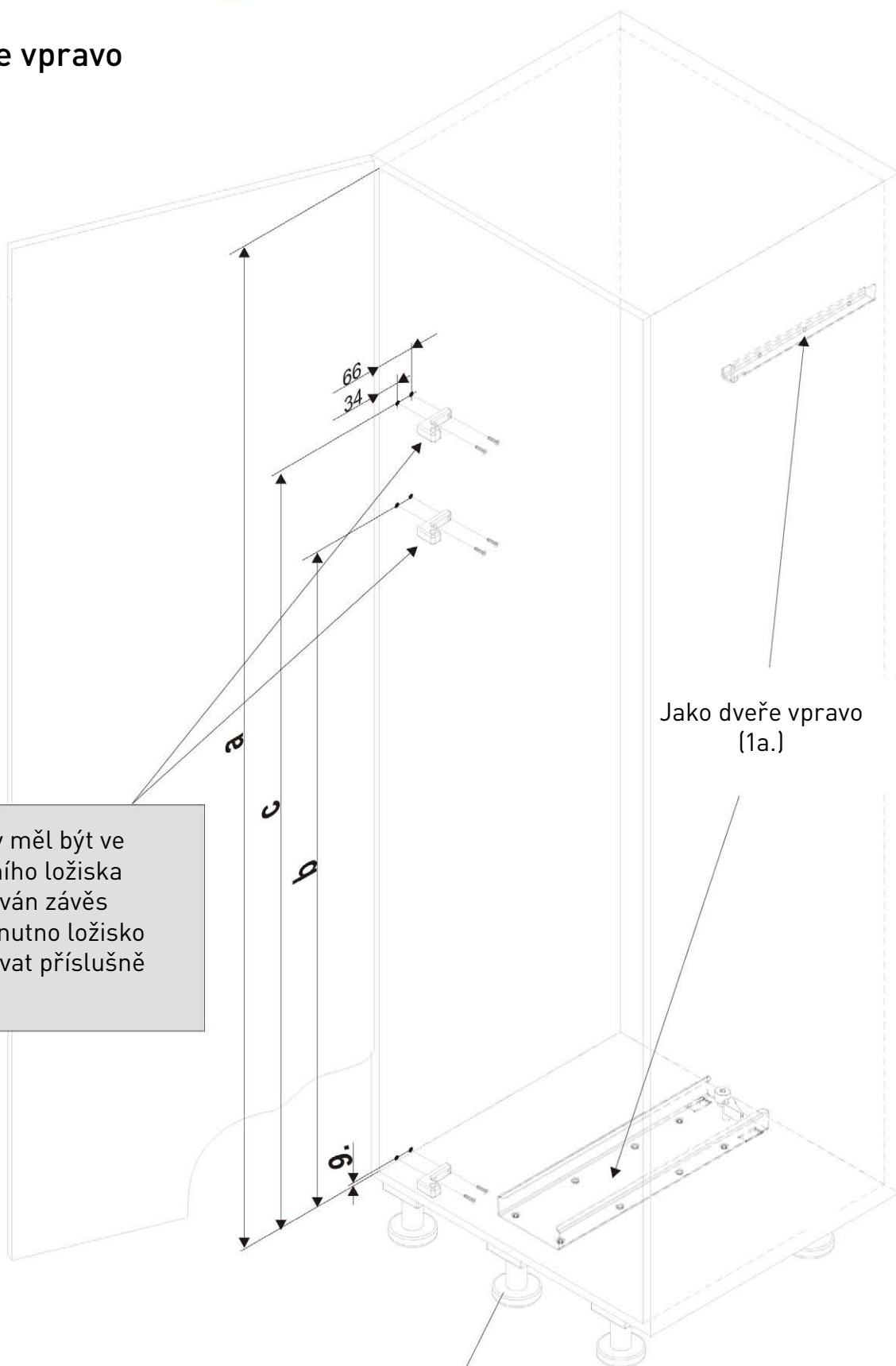
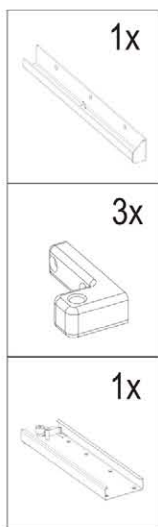

Jako dveře vpravo (1a.)

Pokud by měl být ve výši horního ložiska namontován závěs dveří, je nutno ložisko namontovat příslušně níže.

a	b	c
min. 1100	625	815
min. 1700	1225	1415



## 2. Pravé / Levé dveře

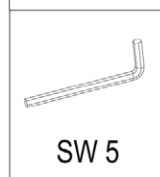
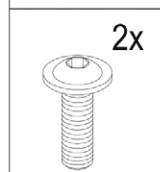
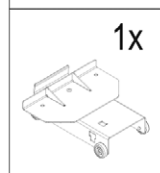
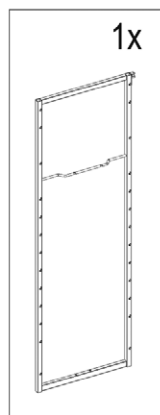

### 3.

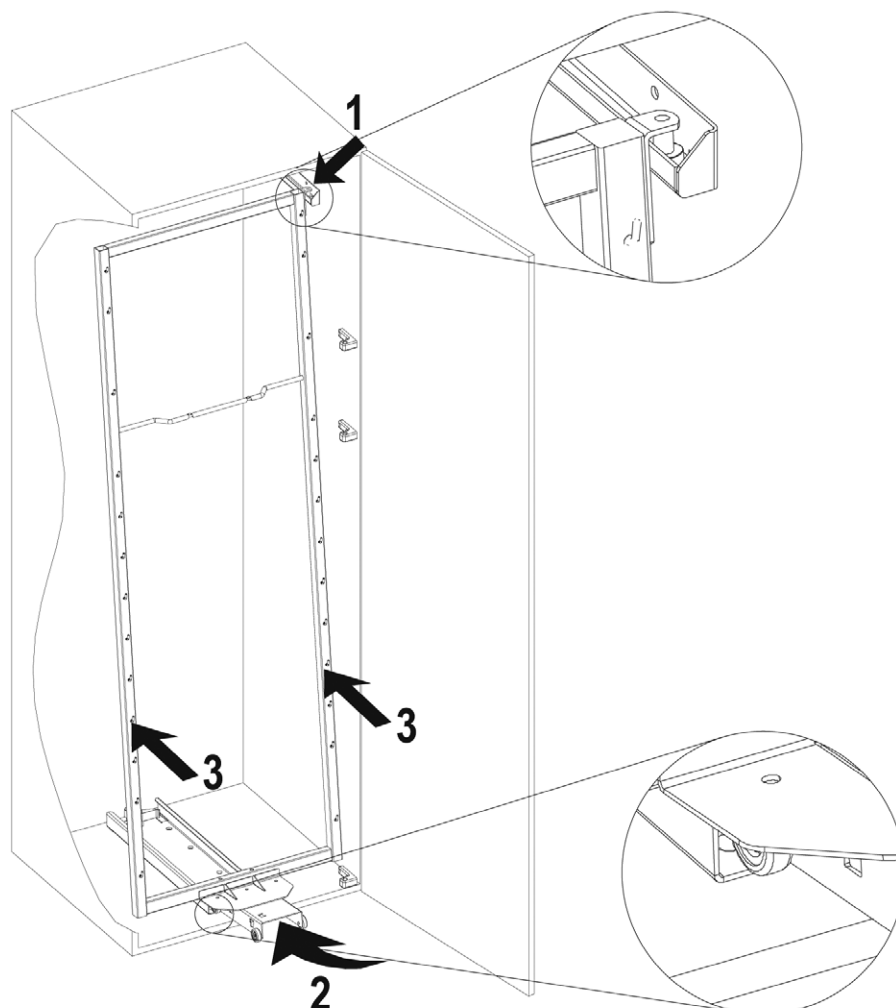
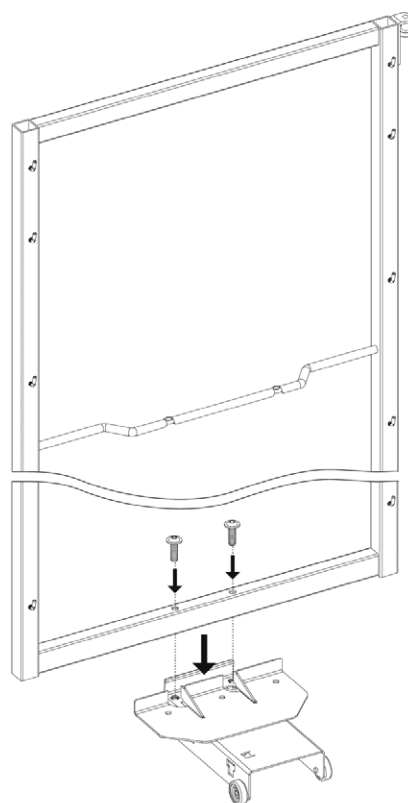
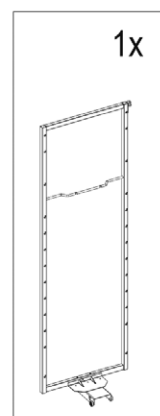

## 4a. Dveře vpravo

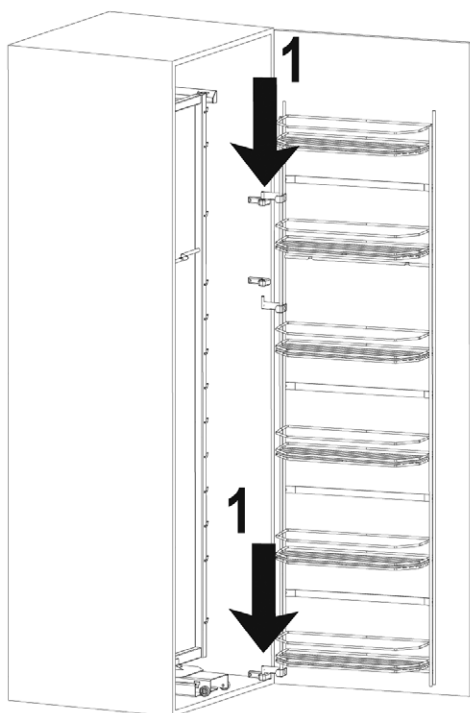

**1** Regál dveří nasadíte do spodního ložiska

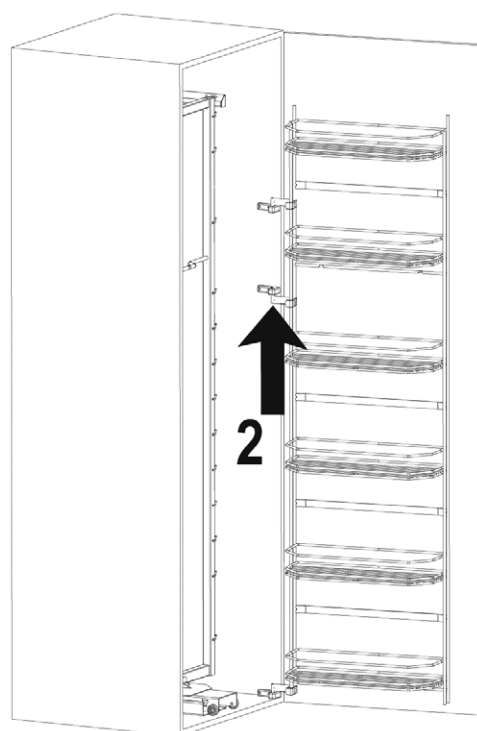

**2** Uvolněte horní připojení dveří, nasuňte je a přišroubujte

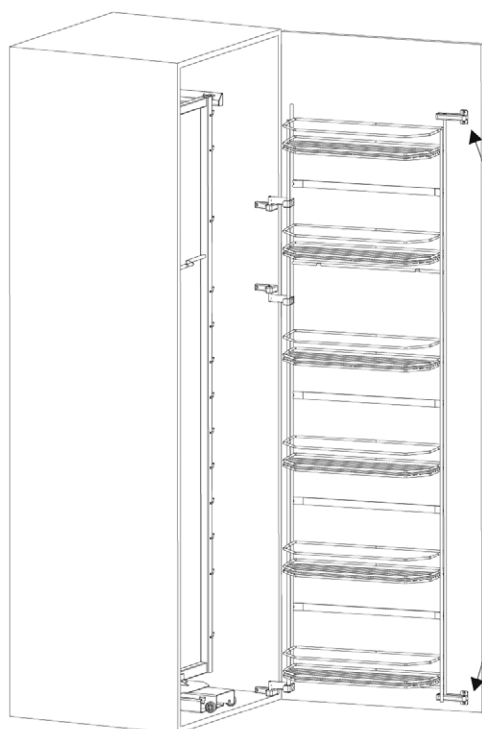
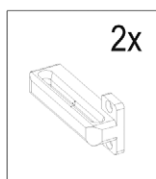

**4** Otevřete regál dveří až na doraz, nahoře a dole nasadíte na regál dveří unášec, určete polohu podle závěsu dveří a přišroubujte jej.

## 5a. Dveře vpravo

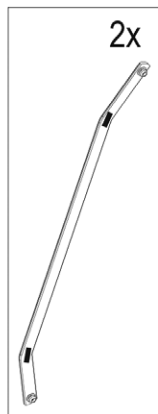

Horní a dolní unášec  
zaklapněte  
v regálu dveří a  
vysunovacím rámu

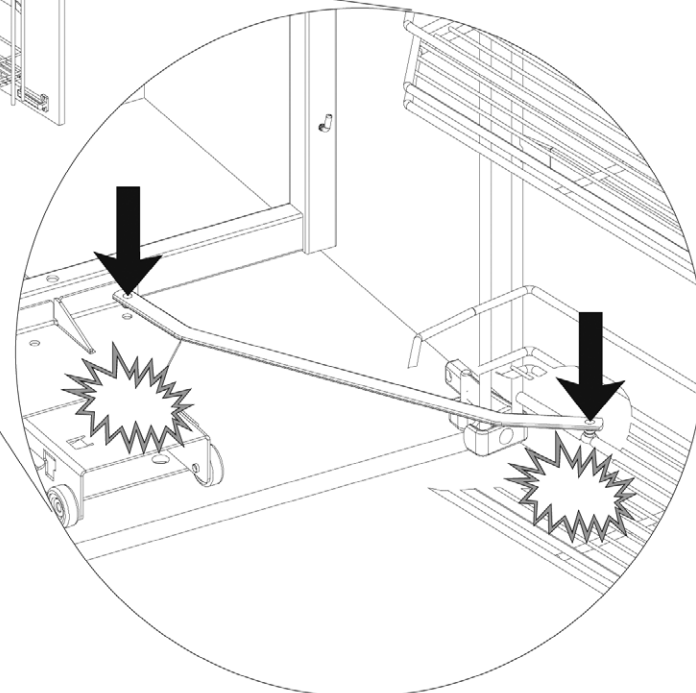
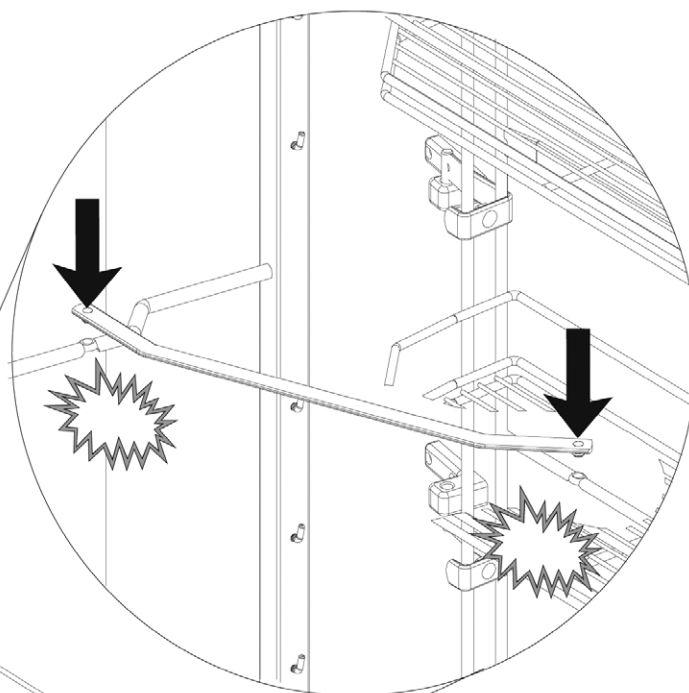
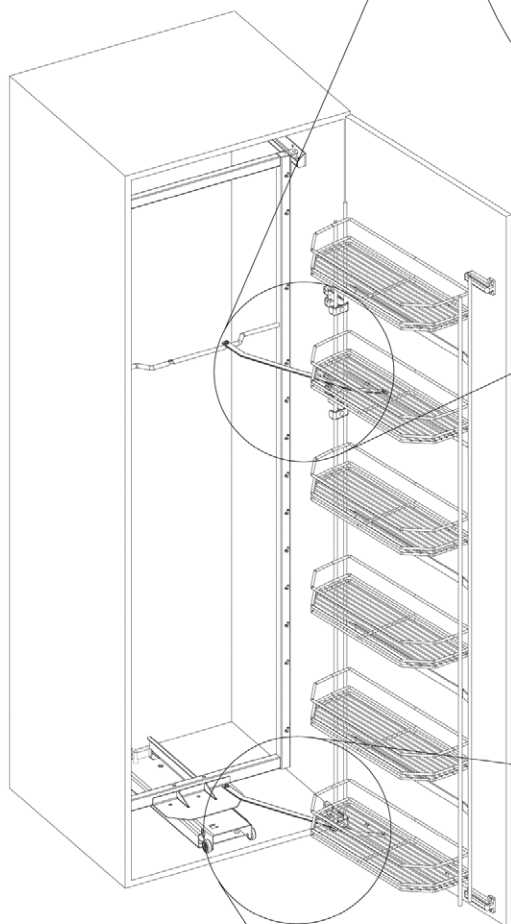

## 4b. Dveře vlevo

Dveře vpravo  
(stav při dodání)

Dveře vlevo

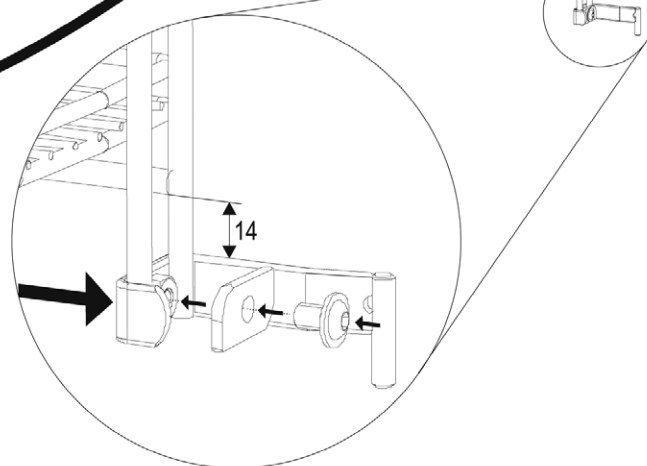
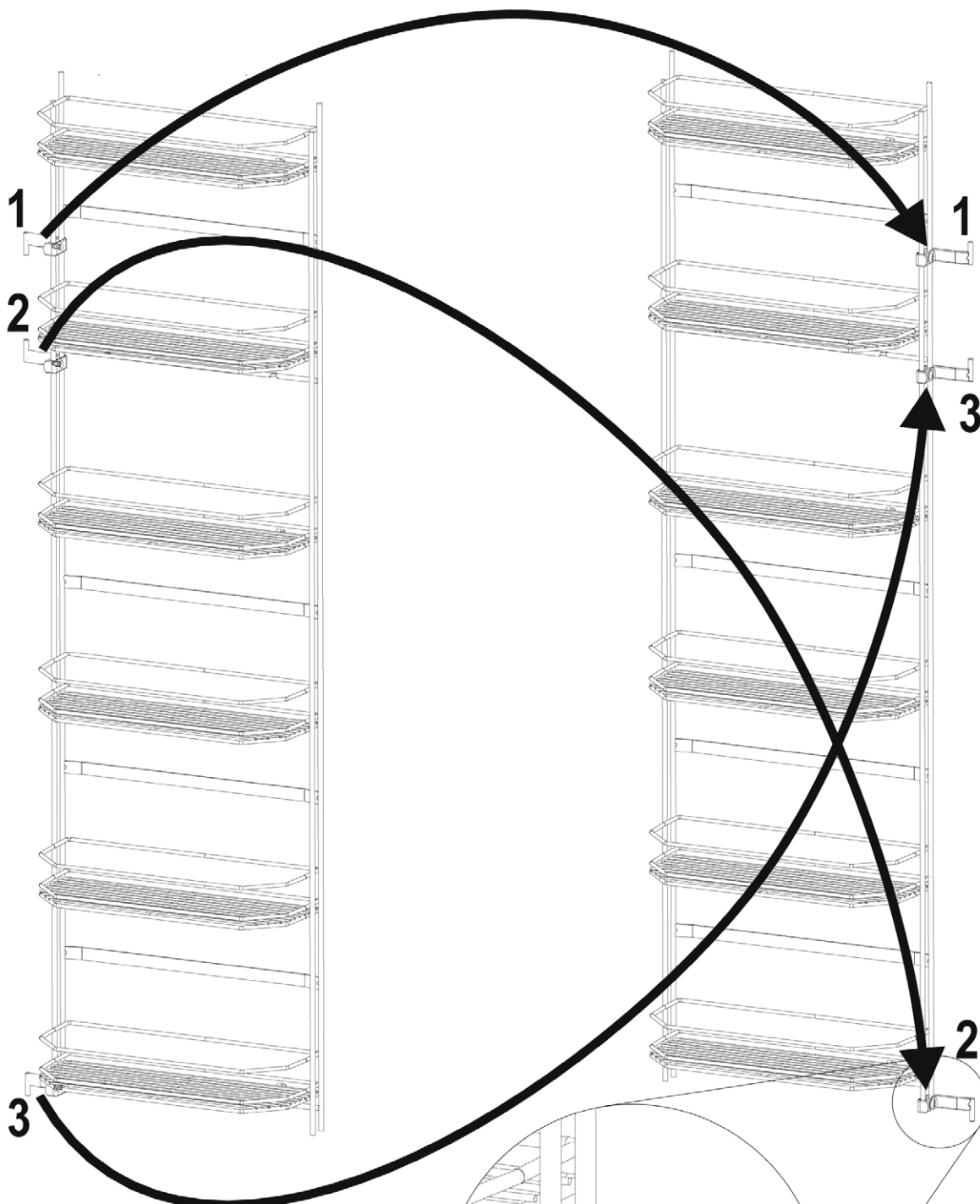

## 4b. Dveře vlevo

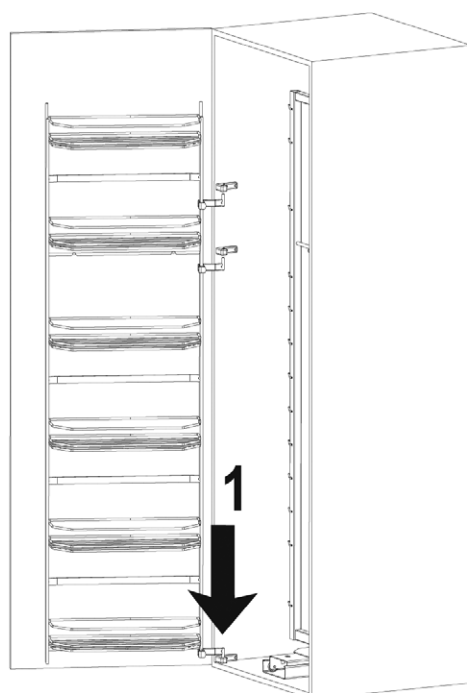
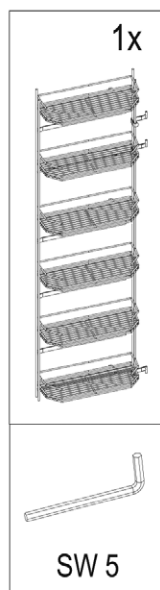

**1** Regál dveří nasad'te do spodního ložiska

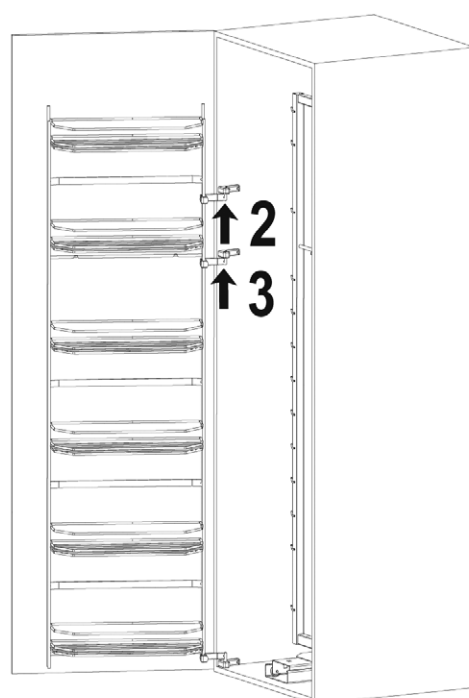

**2+3** Povolte horní a střední připojení dveří, nasuňte je a přišroubujte

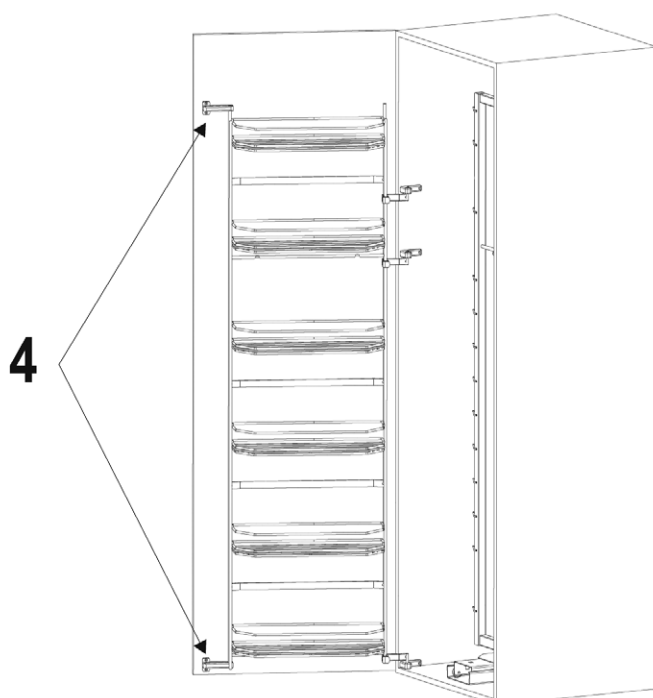
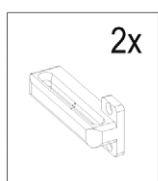

**4** Otevřete regál dveří až na doraz, nahoře a dole nasad'te na regál dveří unášec, určete polohu podle závěsu dveří a přišroubujte jej.



## 5b. Dveře vlevo

2x

Horní a dolní unášec  
zaklapněte  
v regálu dveří a  
vysunovacím rámu

